

Rinnen/Channel:

FILCOTEN parkline 150 BH50 SW17  
BG code: 12515001; 11,9kg

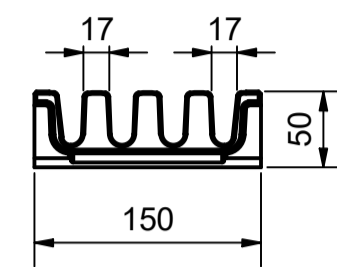

FILCOTEN parkline 150 BH50 SW17 mit Ablauf /  
FILCOTEN parkline 150 BH50 SW17 with outlet  
BG code: 12515071; 11,6kg

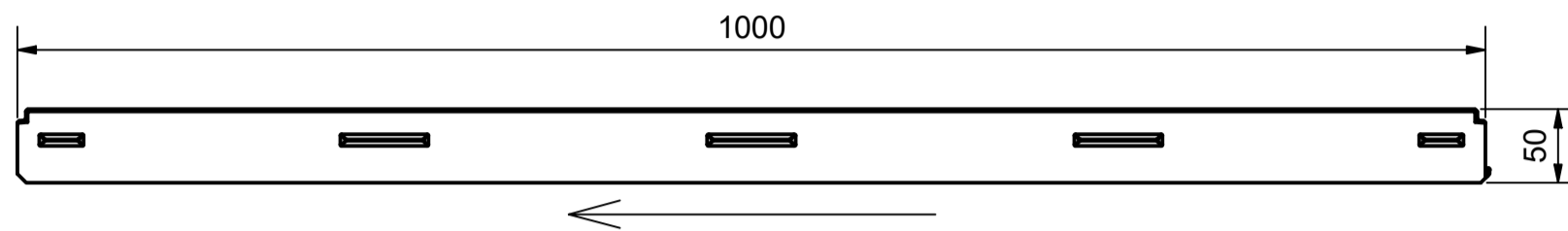
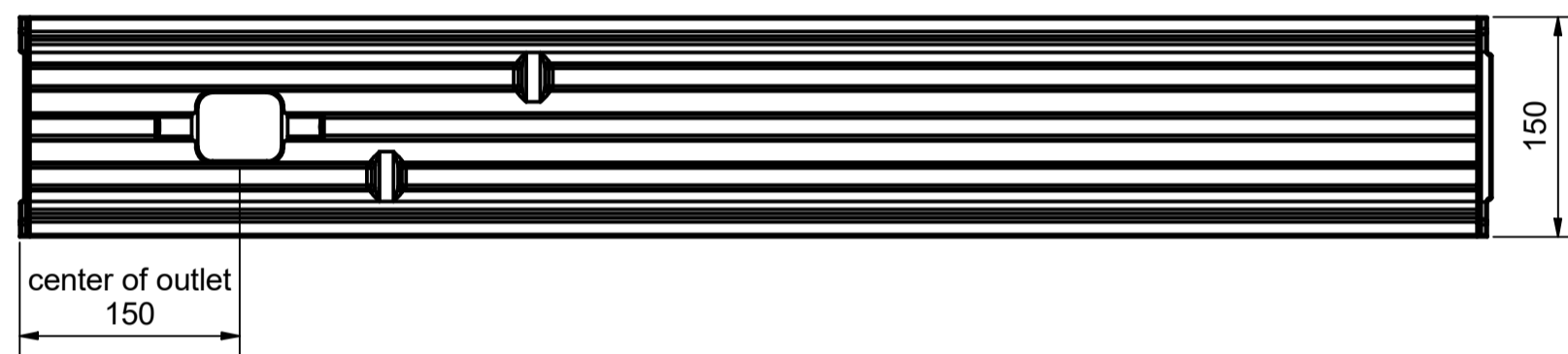
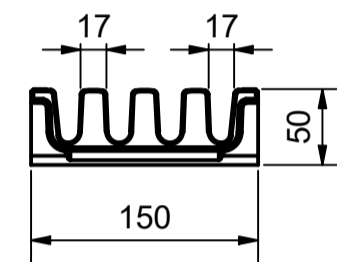
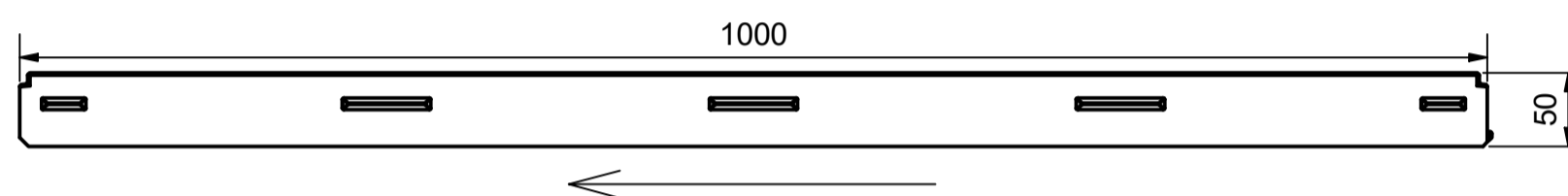

Ablaufabdeckung / Outlet cover:  
BG code: E 12515384; 0,1kg

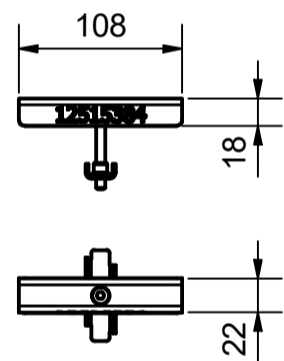

Kreuzungs-Eckelement / Crossing-corner element:  
BG code 12515081; 1,8kg

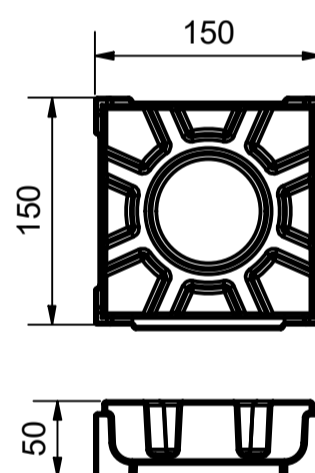

Stirn-/ Endplatte / End cap:  
BG code: E 12515386; 0,1kg

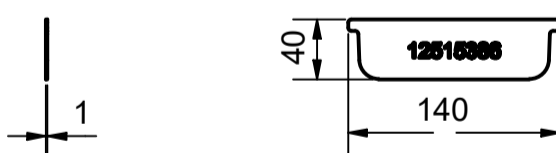

Reinigungsrechen / Cleaning rake:  
BG code: E 12515391; 0,2kg

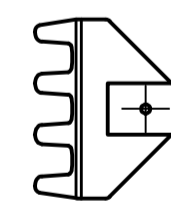
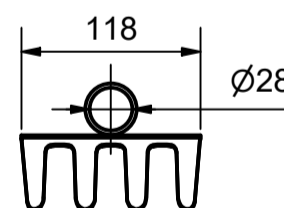

Bauzeitabdeckung / Construction time barrier:  
BG code: V 12515292; 1,3kg

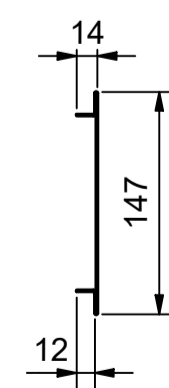
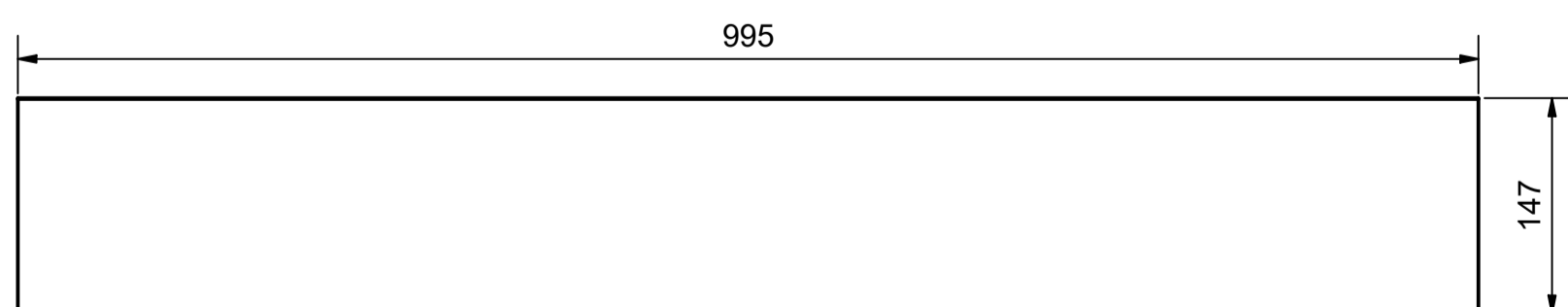

Legende / explanation:	
FCT:	FILCOTEN
E:	Edelstahl / stainless steel
V:	verzinkter Stahl / galvanized steel
G:	Gußeisen / ductil iron
H:	Holz / wood